

## Autosomal DNA Testing

### Successfully Using Autosomal Testing in Conjunction with Mitochondrial and Y-Line Testing to Address Genealogical Questions

*Written by Roberta Estes, [www.dnaexplain.com](http://www.dnaexplain.com), Copyright 2007-2009  
Contact information: [Roberta@dnaexplain.com](mailto:Roberta@dnaexplain.com)*

Most of us can determine quite easily by looking in the mirror the identity of our majority ancestry. Even those recently admixed can see compelling physical evidence of their heritage. Scientists tell us that 25% or more admixture from any particular ethnic group will show in physical traits.

I originally wrote this paper for those who are searching both genealogically and genetically for their Native American ancestors and heritage. However, the concepts are sound for those searching for any minority ethnic heritage, those who are just curious as to whether they carry minority heritage or those who simply want to know how autosomal DNA testing works.

In American history, unfortunately, the records pertaining to Native Americans and sometimes African Americans as well are nonexistent, disguised or buried in some other obscure record. In the case of Native Americans, those who were "reservation Indians" we're taxed and therefore we have absolutely no record of their existence. There were no individual land records since the reservation was held as a "tribe" and those who moved off of the reservation were often exceedingly poor, very marginalized and practiced subsistence living either wholly or in part. Many did not adopt European last names until they had no choice.

Free people of color who are identified as being Indian, African or mulatto which meant any admixture of Indian/European, African/European or Indian/African, were prevented from voting, testifying in court and attending white schools. They owned land much less often than their counterparts of European descent. Most often, these people were sharecroppers, often less fortunate than slaves who were at least provided with food and shelter. They were desperately poor, hungry and barely surviving. Poor white sharecroppers often worked side by side with free people of color, both attempting to scratch a living from their marginalized circumstances.

Without tax, deed, court or other records, the genealogist often reaches a dead end. Unfortunately, money was required for all of these transactions, including obtaining a marriage license, which probably explains many missing records.

We find court records in the NC general assembly sessions where the desperately poor weren't being taxed because they had nothing, but the tax

collectors were instructed to collect poll taxes for them from the land owners on which they lived. Many probably lost their homes because of this legislation.

Enslaved Africans, Indians and many Europeans who were brought as indentured servants lived and worked together. Most indentured servants served 7 years, some more and a few less. Masters tended to work indentured servants harder, with less rest, and more brutally than their slaves that they owned. They knew that with indentured servants, they would only have the benefit of 7 years labor and they intended to get every hour of every day from them. Many died.

During the time of the European's indenture, they often lived and worked in the slave population on the plantation. Nature taking its course, these populations, African, Indian and European established relationships and had children. Eventually laws were enacted prohibiting whites from intermarrying with people of color, free or bond, but that didn't stop nature from taking its course.

Owners of slaves who were bond for life tended to treat them somewhat more humanely than indentured servants, if the circumstances under which slaves lived can be described in that manner at all, because they had a financial investment in their continued health. A sick or dead slave was worth nothing or worse, was a liability.

Indian and African slaves were generally not viewed or recorded differently. In the 1600s and early 1700s we occasionally find a reference to "Indian John" or "my Indian man", although seldom anything that identifies anything more about the individual or his family. Later records show no differentiation at all. Of course, as Indian populations were depleted and African slaves were imported in increasing numbers, there were no new Indian slaves and those already enslaved married with whomever was available on the plantation (or the neighbor's plantation) and soon their offspring were simply "slaves", not Indians.

Slaves of course were also subject to relationships with free men. By the nature of slavery, the slave often didn't get to exercise any right of refusal. Not all relationships between slaves and free men were nonconsensual. Sometimes slaves with whom the owners had relationships were treated better and had positions as "house slaves" as opposed to field workers. Regardless of the individual circumstances, many female slaves were impregnated by their owners, overseers or others with whom they had no right of refusal. Refusal would result in punishment ranging from whipping to being sold away from family, in addition to the forced sexual relations anyway.

As a result of the social situations brought about by slavery, the genealogy of former slaves is most often unknown. Genealogical records for slaves, when available at all, are found in the legal transactions of their owners. Slaves were valuable property, often the most valuable thing owned by their masters, worth far more than their land, as evidenced by the 1850 and 1860 census records in

addition to estate inventories. Slave genealogical records can be found in the deed records, as slaves when sold were often recorded as deeds, wills and estate settlements and also on the slave census schedules of 1850 and 1860. Lucky genealogists will find families grouped together and in estate inventories, families specifically identified as such. Unfortunately, while it's relatively forthright to determine the mother of the children, the father is often much more difficult. Children were the property of the owner of the mother, and fathers might live on a different plantation or there might be multiple fathers due to varying circumstances. Unfortunately, much of this type of genealogy must be surmised. It's inferred, for example, not known, that children found with a woman are her children unless an estate packet or chancery suit says otherwise.

While most people whose ancestors were slaves know they are of African descent, what they don't realize is that they are also very likely of American Indian descent as well. Prior to the beginning of large scale importation of African slaves into America, Indians were routinely enslaved.

American Indian tribes were constantly at war among themselves. Prior to the settlement of Europeans, they either killed their (primarily male) captives, incorporated them into their tribe, or enslaved them themselves.

After European settlement began, Indians quickly discovered a market for their captives and they began capturing men, women and children and selling their captives into bondage. This had the unintended effect of depleting the Indian population as a whole. Previously, if the captive had been incorporated into the tribe or even enslaved by the tribe, they had the ability to continue to contribute to the native population and often had children within the tribe with which they lived. By selling their captives to Europeans, those not sent to the West Indies were no longer within the indigenous population, but were effectively now within what would become the African slave population. Both American Indian and European heritage would become obscured by the African heritage.

Americans today whose family has a heritage of slavery aren't terribly surprised to find European DNA on their paternal side, and about 30% find this result. Many are surprised to find European DNA on their maternal side and most are quite surprised to find Native American DNA on either side.

Native Americans and Africans have been enslaved together on the American soil since at least 1619 in Jamestown when the first slave ships arrived. For the next 243 years, or about 10 generations, the institution of slavery provided the social environment for undocumented admixture between European, African and Indian populations. In fact, in the 1700s in the records of the North Carolina General Assembly sessions, more than half of the petitions for manumission were indeed for those noted as mulatto or mixed. Ironically, it isn't the African heritage that has been lost in the shuffle, but most often the Indian heritage that

is entire missing from family oral histories. Bondage itself was considered evidence of African heritage.

Indians being integrated into slavery wasn't a one way street however. Many times slaves ran away and were taken in by the various tribes as members. As tribes became smaller through disease, warfare, integration with European culture and the effects of forced relocation, their remnant tribes merged. The Cherokee, for example, were known to take refugees, including escaped slaves, and they welcomed other tribal remnants as well to swell their ranks.

What does this mean to the family historian who is trying to prove their genealogy and understand better just who they are and where they come from?

If your family has a long-standing oral history of minority heritage, it is probably true. However, finding the person who carried that heritage is often quite challenging. Historically, Native people were classified as "non-white" which severely limited (and sometimes prevented) their ability to function in a primarily white society.

Furthermore, laws varied and how much non-white heritage constituting "people of color" ranged from the infamous "one drop" rule to lesser admixture, sometimes much more liberal, to only the third generation. In essence, as soon as individuals could become or pass for "white" they did. It was socially and financially advantageous. It is not unusual to find a family who moved from one location to another, often westward, and while they were classified as mulatto in their old home, they were white in their new location.

Often there were only three or sometimes four classifications available, white, negro or black, mulatto and Indian. Sometimes Indian was a good thing to be, because in colonial states, reservation Indians weren't taxed. However, this also means their existence in a particular area often went unrecorded. Often, poor "free people of color" weren't taxed either because they lived and worked on someone else's land and they had nothing of value. Because of their poverty and resulting lack of records, they became invisible to the genealogist.

Any classification other than white meant in terms of social and legal status that these people were lesser citizens. Therefore, Native American or other heritage that was not visually obvious was hidden and whispered about, sometimes renamed to much less emotionally and socially charged monikers, such as Black Dutch, Black Irish and possibly also Portuguese.

For genealogists who are lucky, there are records confirming their genealogy, such as the Dawes Rolls and other legal documents such as slave owner records. More often, there are only hints, if even that, such as a census where an ancestor is listed as mulatto, or some other document that hints at their heritage. Most often though, the stories are very vague, and were whispered or

hidden for generations. References may be oral or found in old letters or documents. Supporting documentation is often missing.

Many times, it was the woman of the couple who was admixed initially, of course leading to admixed children, but with 50% less admixture than their mixed parent. It was much more common for a male of European stock to intermarry with Native or admixed women, rather than the other way around.

This means to genetic genealogists today, that they are likely to meet with frustration when attempting to document minority heritage.

Let's take a look at DNA testing, the various kinds available, how they can assist us with our genealogy and what they mean.

### **DNA Tests**

To avoid confusion, this is probably a good place to mention that DNA testing is not accepted by any tribe for membership. Each tribe has its own membership criteria and to my knowledge, none accept DNA as either proof or disproof.

Tribes typically require a percent of "blood quantum", such as 1/4<sup>th</sup> or 1/8<sup>th</sup> and in addition they generally require that you be of proven descent from an individual about whom there is no question of their tribal Native heritage. This is most often accomplished by the inclusion of the family in question on specific tribal rolls, plus proven descent from that family, and that the applicant is not currently less than a specific percentage Native American.

Conceptually, this means that you could very well be mostly Native American, with 7 of your 8 direct great-grandparents being 100% Native American, but your father's direct paternal line being European. With proven genealogy to the tribes specifications and being 7/8<sup>th</sup> Native American, there is no question that you would be accepted on the tribal rolls. However, a Y-line DNA test would reveal the European haplogroup of your father's paternal line is not of Native heritage.

Given the above example, you can never interpret non-Native haplogroup results of any one line to answer the much broader questions of, "do I have Native heritage", "how much" and "where". What you can do at that point is to continue to test other lines in order to discover the identity of your Native American ancestor. You will need to create a DNA pedigree chart. But first, let's take a look at the different kinds of DNA testing and what they can tell you about your heritage.

There are 3 different types of DNA tests that can be used to either confirm or hint at Native ancestry; Y-line, mitochondrial DNA and autosomal. There are two types of autosomal testing, that based on the forensic CODIS markers and that

based on biogeographical ancestry markers. Let's take a look at these different kinds of tests and what they can to help us identify our Native ancestors.

### **Y-Line – Paternal Line Testing**

Y-line DNA tracks the male's paternal line through the Y chromosome that is passed from father to son. This DNA also follows the last name of the father, so projects tracking these families are called surname projects. Comparatively speaking, these are easy to manage because a male carrying the last name of interest is obvious.

Y-line DNA can tell you whether or not you descend from a common male genealogically when compared to another testing participant. It can also tell you by identifying your deep ancestral clan whether or not you descend from early Native Americans who were here before contact with Europeans. For that matter, it can also tell you if you descend from those of African, European or Asian ancestry.

Scientists know today that there are only two primary haplogroups indicating deep ancestry that are found among Native American males who were here prior to contact with Indo-Europeans, and those haplogroups are C and Q. It is not accurate to say that all C and Q individuals exist only in the American Native population, but the American Native population is part of the larger group worldwide that comprises C and Q. Subgroups of haplogroups C and Q which we find only among the American Indians are C3b (also known as C-P39) and Q1a3a (also known as Q-M3). We find no C-P39 or Q-M3 in European or African populations, although we do learn more every single day in this infant science.

This sometimes becomes confusing, because the single most common male haplogroup among current Cherokee tribal members who have tested is R1b. How can this be, you ask? Clearly, one of three possibilities exists:

1. The Cherokee (or those tribes who were assimilated into the Cherokee) adopted a European male into the tribe or a European male fathered a child that was subsequently raised as Cherokee.
2. The R1b ancestor was not adopted into the tribe, maintained their European/American identity but married a Cherokee individual. This might be the case where one of the 8 great-grandparents in our example was European (white), and the other 7 were not.
3. There is some level of R1b admixture in the Native Population that preceded contact with Europeans that we have not yet identified.

Given this situation, I want to be very sure that people do understand that DNA results and tribal membership are not related.

Because of the unique haplogroups for Native Americans who preceded European contact, Y-line is the only way to positively confirm that a specific line is or is not of Native American descent. This obviously applies to all of the individuals in the pedigree chart who directly descend from the oldest known ancestor in this paternal line.

Y-line testing does not indicate anything about the contributions of the other ancestors in this family tree.

### **Mitochondrial DNA**

Mitochondrial DNA tracks the participant's maternal line. Mitochondrial DNA is passed from the mother to all of her children, but only the females pass it on. So both men and women can test themselves to reflect the mitochondrial (mtDNA) DNA of their mother, but following it up the ancestral tree, the path of ascent is only through the mothers. Your mtDNA is the mtDNA of your mother, her mother, her mother, etc. on up the tree following only the maternal line.

MtDNA testing is not as popular as Y-line testing because it's more difficult to use genealogically as last names change every generation. When you look at your matches, you have no idea whatsoever if you might be related to these people in a genealogically relevant time frame by looking at their last names. Those who have put forth the effort to collaboratively work on their mtDNA matches, assuming a high resolution match and a shared geographical history as well, have been pleasantly surprised by what they've found.

A haplogroup assigning deep ancestry is also provided through mitochondrial testing, so like the Y-line, depending on the haplogroup assigned, you will know if your ancestors were here before the age of European contact. Female haplogroups that indicate Native heritage include A, B, C, D and X, although, like Y-line, these major haplogroups are also found in Eurasian populations while typically subgroups are found in the Americas.

The certificate below shows a typical certificate from the mtDNA test. Some additional information, along with matches, is available on the participant's personal web page if they are Family Tree DNA clients. Clients of other testing companies receive varying amounts of information ranging from none to a printed report.

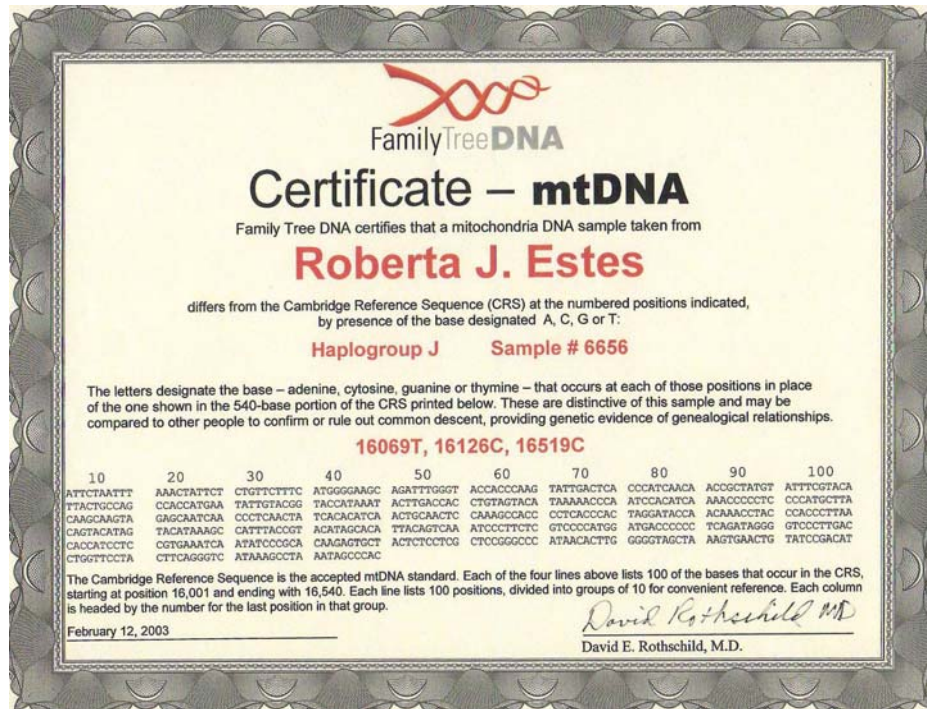

The pedigree fan chart below, courtesy of Family Tree DNA, shows the inheritance pattern for both Y-line and mtDNA.

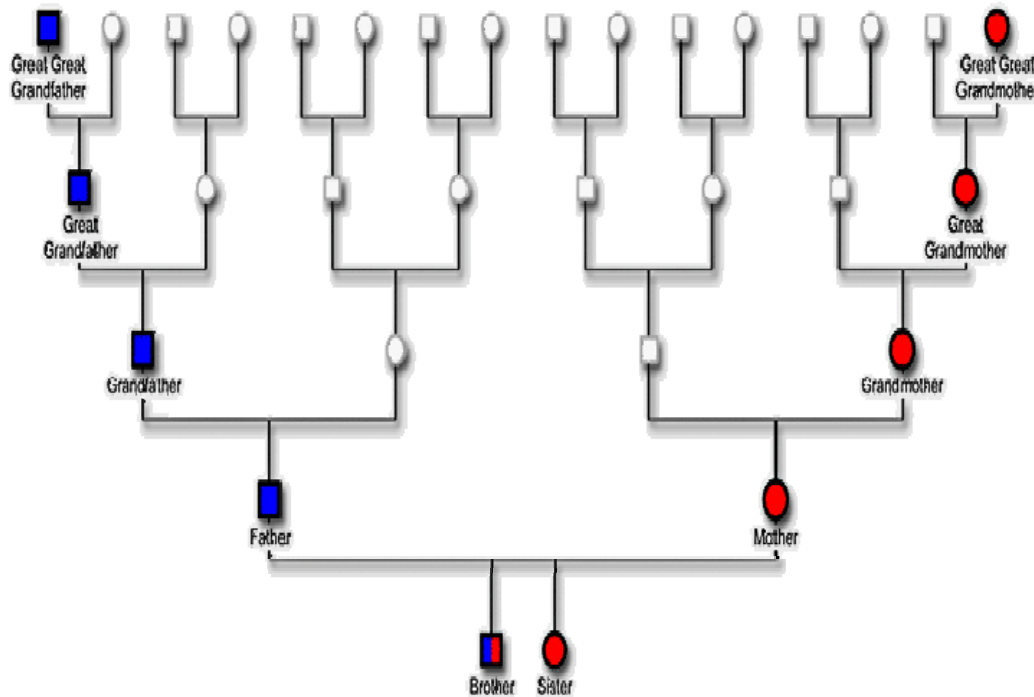

Notice that of the 16 individuals shown as the great-great-grandparents of the siblings, the Y-line and mtDNA positively identify the deep ancestry of only two of the 16 branches, leaving 14 unidentified. It is certainly possible that their Native

heritage descended through their father's family pedigree, but was not reflected in the Y-line of that line. The Native American individual could have been any of the people on the father's half of the tree other than the surname branch that was tested, or perhaps even someone further up the tree not shown here.

Both Y-line and mtDNA can provide this level of deep ancestral accuracy because both are passed from parent to child without being admixed with any DNA from the other parent, allowing us today to determine exactly what the DNA of those paternal and maternal ancestors looked like, with the exception of an occasional mutation.

Because of the accuracy of both Y-line and mtDNA testing, I strongly encourage people to attempt to complete their Personal DNA Pedigree Chart (see article by Roberta titled "Creating Your Personal DNA Pedigree Chart") by finding appropriate testing candidates, representatives of the other genealogical lines found on their tree. It may indeed require some work, especially to identify individuals descended through maternal lines with last names changing each generation, but it is the only way to accurately reconstruct your genetic heritage.

Y-line and mitochondrial DNA testing is the only way to positively identify which individual line or lines were of Native (or African, European or Asian) heritage, although other types of tests, called autosomal and/or biogeographical tests can be done to indicate the existence or absence of Native American (or other) heritage, no other tests can pinpoint where the Native heritage entered the family tree and which ancestors were of Native heritage.

### **Autosomal DNA Testing**

Unlike Y-line and mtDNA testing where the DNA of the father or mother is passed to the offspring unmixed with that of the other parent, autosomal testing tests portions of the DNA of an individual that they receive from both parents. As the field of genetic genealogy has moved forward, research has begun to indicate that certain markers are found in higher or lower amounts in different ethnic populations.

For example, if someone has the Duffy Null allele, or genetic marker, we know they positively have African admixture. We don't know how much African admixture, or from which line, or when that individual with African admixture entered their family tree, but we know for sure they existed.

Attempting to determine the population frequency of varying markers and what that means relative to other populations is the key to this analysis. Few markers are simply present or absent in populations, but are found in varying frequencies. Some populations are widely studied in the research literature, and others are virtually untouched. The process of compiling this information in a meaningful manner so that it can be analyzed is a formidable task, as the information is often

found in nearly inaccessible academic and forensic research publications. It's difficult to determine sometimes if the DNA analysis of 29 individuals in a small village in northern Italy is, for example, representative of that village as a whole, of northern Italy, or more broadly for all of Italy as a whole. Is it representative of Italy today or Italy historically? These and other similar questions have to be answered fully before the data from autosomal testing can be useful and reliable.

If the DNA tests being performed aren't mtDNA or Y-line, then they are autosomal tests, meaning they are performed on the balance of the DNA contributed by both parents to an individual.

Before we discuss the varying kinds of autosomal tests and what they mean, let's take a look at the inheritance process and how it really works.

## **Inheritance**

Everyone knows that you inherit half of your DNA from your mother and half from your father. While this is technically true, you don't receive 25% of your DNA from each grandparent.

While each child does on the average receive 25% from each grandparent, the actual inheritance pattern varies much more than that and each sibling may receive far more, or less, than 25% of their markers from any grandparent.

We don't understand today how inheritance traits are selected to be passed to children. Each parent receives 50% from each of his parents, but how this is combined and reduced to the "half" that is passed to each child is unknown. Every individual has 2 chromosomes in each pair, one from each parent, but their DNA recombines to create one "new" chromosome to be passed to each of their children.

Some "groups" of genetic material are inherited together, and you may wind up with more or less genetic material from one of your grandparents. In time, certain genetic "traits" will be lost in some descendants, while not in others. Therefore, you can't figure actual inheritance percentages by using the 50% rule. This means that if your father was 50% Native American, you are not necessarily 25%, genetically speaking. You may receive 10% of his Native genes and your sibling may receive 40%.

Let's use the Duffy Null allele we mentioned earlier as an example. This marker could have entered your DNA pedigree chart with a grandmother who carried the allele but had no obvious visible African ancestral traits, or from your father who might have been visibly African in ethnicity. The Duffy Null allele, which is just one marker, could have been passed in the inheritance of DNA for many generations, far after any visible physical African traits had disappeared, or it could be one of many African traits passed from parent to child. It is also

possible that an individual who is admixed, whether they know it or not, and physically appears to be African (or of African descent), has lost the Duffy Null allele someplace along the line in recombination and transmission.

The relevance of the Duffy Null allele is determined by the number of other “African” markers that appear in high quantity. If there are few other African markers, then your African ancestry was likely further back in time. If there are many, then your African ancestry was likely more recent. These statistical calculations are how the importance of autosomal markers are determined and how percentages or estimates of ethnicity are calculated.

Any one allele or marker can be lost permanently in any generation. Each child receives one gene from each parent. In the example below, let’s say that the mother carried genetic markers A and B, and the father C and D, and D is the Duffy Null allele.



- Child 1 – A and C
- Child 2 – A and D
- Child 3 – B and C
- Child 4 – B and D

You can see that half the children received the D marker, but each inheritance event was a random recombination of the markers. It is also possible that none of the children would receive the D marker, or all of them would receive it. Statistically speaking, half will receive the marker, but statistics and individual inheritance are two different things. Random recombination is the reason why siblings who take autosomal tests sometimes show significantly different results.

You can also see how a marker that is very old ancestrally, meaning introduced many many generations ago, could be absent in one entire descendant line and present in another line.

From the above examples, we see that we have two variables that we need to deal with when attempting to use autosomal DNA for genealogy.

First, we need to take into consideration inheritance patterns which we can’t determine retrospectively without testing several descendant lines. So, in essence, we can only deal with, and test, what we personally carry today as our genetic inheritance.

The second variable is determining population frequency for a particular marker and understanding its significance to us through comparative population genetics.

This is why autosomal testing can give us important hints, but is often considered “unreliable”. The results are highly subjective today, but increase in accuracy as more research is completed, compiled, published and analyzed.

## Types of Autosomal Tests

There are two types of autosomal tests used today for genetic genealogy. One type of test uses the Codis forensic markers and the second type, biogeographical tests, use a much broader spectrum of marker results called AIMs (Ancestry Informative Markers). Let’s look at both types of testing and the information they provide separately.

**Codis markers** are a standardized set of autosomal markers used for paternity and siblingship testing. Additionally, they are used by police departments and forensics labs. The markers employed in these tests are selected specifically to differentiate between people in order to identify them individually, not to find common markers to place them in ethnic groups.

The results from these tests are only numbers, and the recipient is often left to their own devices as to how to interpret the results. These tests are available from numerous sources. I prefer to interpret these results in conjunction with Y-line and mitochondrial DNA test results for as much of the genetic pedigree chart as can be provided in order to obtain a more complete genetic picture.

Below is an example of what Codis test results look like. They are very similar from any lab.

Location	Mother	Child
CSF1PO	10, 12	10, 12
D2S1338	17, 25	17
D3S1358	17, 18	17, 18
D5S818	11, 12	11, 12
D7S820	8	8, 9
D8S1179	12, 14	12, 13
D13S317	12, 13	13
D16S539	11, 12	11, 12
D18S51	12, 13	12, 20
D19S433	12, 14	14, 15
D21S11	30, 31.2	31, 31.2
FGA	20, 24	20, 24
TH01	6, 9.3	6, 9.3
TPOX	11	8, 11
vWA	17	17, 19

## Analysis of Codis Markers

Unless you're using the Codis marker results to determine siblingship or some other personal reason, these numbers are fairly useless genealogically. It's the analysis of these markers that matters.

There are different avenues to analyze Codis results. None are "right" or "wrong". DNAexplain ([www.dnaexplain.com](http://www.dnaexplain.com)) provides analysis of these tests, along with broader more comprehensive analysis of genetic genealogy and what all of these tests together mean about you.

We use a combination of resources, both public and private, including Omnipop and other European and Canadian autosomal forensic data bases.

Tribes ([www.dnatribes.com](http://www.dnatribes.com)) has been compiling population data on these genetic markers for some years now and will compare your autosomal results with their data base. Take a look at their samples tab.

Ironically, the results may vary significantly between these resources. There is no "right" or "wrong" answer at this point. I encourage everyone to simply view these results as "data", hints to puzzle pieces. As the data bases improve and we better understand population migration and movement, the clarity of the results will improve too.

Tribes early population tables did not include data from the British Isles, so their results were highly skewed towards other world populations. Omnipop today relies on self-reported ethnicity and does not include normalized data (or a normalizing factor) for varying populations. Because Tribes is a private company, we don't know much about their population data, whether it's widely representative of the world population distribution and whether it has been normalized or not.

To learn the most about your autosomal test results, you can take a dual approach, having them analyzed by Tribes as well as by DNAexplain using the other autosomal codis reference tools. We'll be glad to help you through this process and provide a summary analysis of both.

Testing for the Codis markers is available though Family Tree DNA and also through DNATribes. If you are purchasing this test from any other lab, be sure before you purchase the test that it includes the various markers needed for Omnipop and the DNATribes analysis.

### **DNAPrint Genomics**

Biogeographical ancestry testing was previously available from DNA Print Genomics ([www.dnaprint.com](http://www.dnaprint.com)), however, they have now filed for bankruptcy and are out of business. However, biogeographical testing is the second type of

autosomal testing and many people in the genealogy marketspace have taken this test. DNAPrint evaluated all of your genetic contributions for specific, proprietary markers that indicate geographical heritage, not just the Y-line or mtDNA. Results were returned as percentages of Indo-European, Asian, African and Native American.

They did not use the Codis markers, but use, depending on your test selected, between 500 and 1349 biogeographical markers they had discovered to be relevant to ethnicity.

This test itself was only available from only one source, DNAPrint, although the test was resold by several other companies under varying names. Results from this test were returned as percentages of ethnic heritage as shown below.

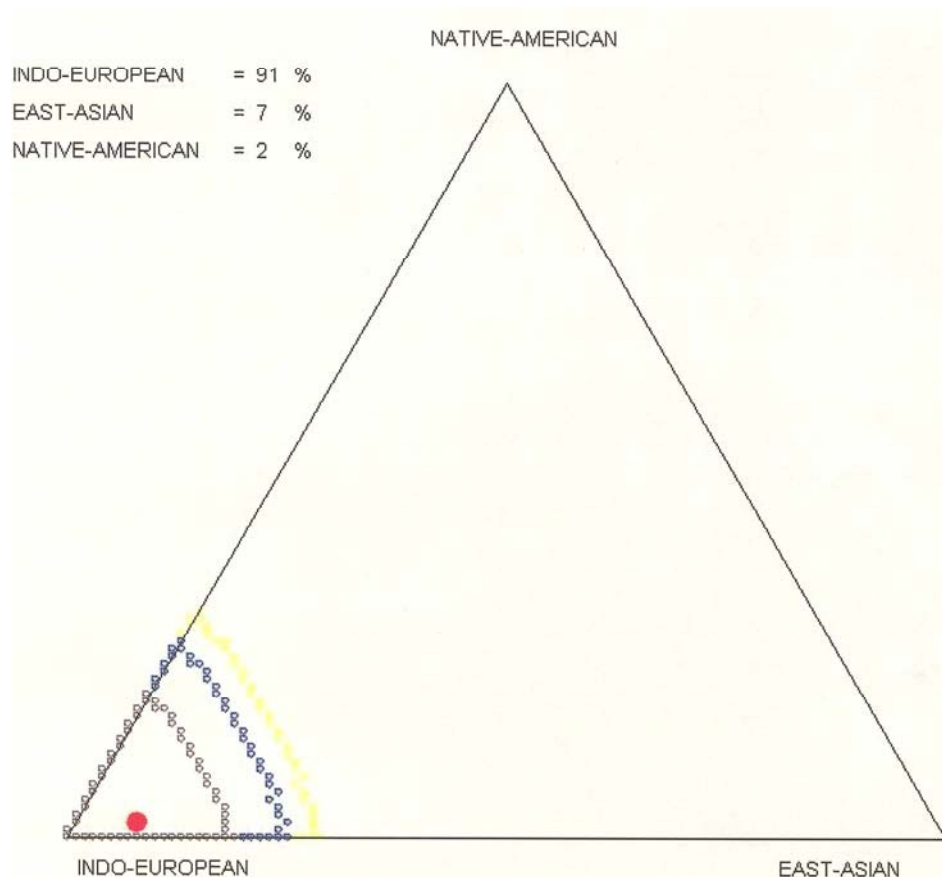

Results were reported within confidence bands, which indicate a range of percentages that might actually be accurate. This is shown above by the bands surrounding the red dot which shows the “most likely” result. The margin of error is often as high as 15%. Typically, there is no dispute over the majority ancestral type. However, minority types are apparently much more difficult to discern. Because of the wide and sometimes surprising range of results, this test was often considered unreliable, but the degree of unreliability sometimes was determined by how pleased the tester was with their results.

It is unfortunate that DNAPrint is now defunct. While the test did indeed need refinement, without continuing research, there will never be a test to offer this type of information to consumers who seek answers otherwise unavailable to them.

Having said that, let's talk about the concept of statistical noise, which in this case (DNAPrint) according to their documentation was as high as 15%. All testing that deals with statistics, which means by virtue of the nature of the beast, all population based autosomal tests today, deal with "statistical noise" at some level.

### **Statistical Noise**

Statistical noise is easy to understand. It's a scientific word that means the percentage of "slop" in the calculations based on what they don't know. When scientists perform calculations based on populations, they have to sample an incredibly large number of individuals for the law of averages to work in their favor.

For example, sampling 50 individuals from inner city Detroit may not be reflective of the entire state of Michigan's population or even of the population of Detroit itself, depending on which neighborhood you've visited to collect samples. However, many companies base their entire estimates of heritage on 50 or fewer samples from particular countries.

A much more reasonable and accurate approach would be to take samples from a percentage of people, based on population, throughout Michigan. That approach is difficult and expensive. To attempt to compensate for the issues inherent in the smaller sample approach, there are various calculations that are used on the results to "normalize" them. The resultant "unknown" or "margin of error" is considered statistical noise. It's much like the political surveys taken that are always qualified by "+ or - a 5% margin of error".

So what does this mean to genealogists trying to understand their results?

What this means is that any number that you received could in actuality be 15% higher or lower than stated. For majority ancestry, this is not a problem, but for minority ancestry, which is the information most people are seeking, it represents a huge problem. Looking at the East-Asian and Native American results above, that means that they could actually be zero to 22% (East-Asian) or 17% (Native American).

Now let's connect this to genealogy.

If we use the figure of 50% inheritance in each generation, knowing that it's imperfect because we don't receive 25% of our genes from each grandparent, we know the following about our individual inheritance.

Parents – 50% from each one  
Grandparents – 25% from each one  
Great-grandparents – 12.5% from each one  
Great-great-grandparents – 6.25% from each one

For most of us, average age of 50 (genealogists don't tend to start young), and with an average generation length of 30 years, this equates to the following information:

Us – born about 1960  
Parents – born about 1930  
Grand-parents – born about 1900 (we probably knew them)  
Great-grandparents – born about 1870 (we probably didn't know them, but our grandparents and parents told us about them)  
Great-grandparents – born about 1840 (we definitely didn't know them, but we probably knew who they were genealogically as our grandparents knew them)

For most people, if our great-grandparents had been Asian, African or Native American, born about 1870, we would have known it. In this generation, we are within the statistical noise 15% ration as we only inherit (on the average) 12.5% from each of these individuals. If they were “full blooded” anything, it wouldn't be a secret that needs to be ferreted out by DNA testing.

By 1870, there were very few American Indian people who were not admixed with European or African ancestors, although they might have been unaware of that fact if it occurred several generations previously. Most of the least admixed individuals were on reservations by 1870 or living in the west. Indians living in the east were admixed enough to not have been removed in the 1830s.

By the great-grandparents generation, we are now at the 6.25% level, well with the noise range, but within the timeframe where we should receive at least some oral history. The 1850 census is our friend here, as we can determine where they lived, if they were on a reservation, and if they were considered anything other than “white”, such as black or mulatto, as many admixed American Indians were labeled.

Most people who seek to discover their Native American ancestry are by necessity looking back before the “Trail of Tears”, often to the tribes that were exterminated by the colonists before the Revolutionary War. Remnants of those tribes intermarried with whites and free people of color as well as joining the tribes still existent, such as the Cherokees and Creeks who were later removed.

Unfortunately, on the genealogy chart, this takes us back another two generations to ancestors born in 1810 and in 1780. Respectively, we carry an average of 3.125% and 1.56% of their DNA. The next generation back, born in 1750 before the Revolutionary War, we carry less than 1%, on average, of their individual DNA.

It's no wonder that the autosomal tests have such a difficult time finding traces of our Native ancestors. Unfortunately, because of the way DNA is recombined and transmitted generation to generation, we simply can't unlock those secrets to day. What we can do is to participate in new testing as it comes along and use the various pieces of information available from each type of test to build our "case".

### **DNATribes**

DNATribes has been a provider of products in the genetic genealogy field for several years. They use the Codis markers and provide an analysis from their data base relative to the markers and the populations in which they are found. They combine this population data into a trend and provide you with a report based on their findings as to which populations you are most likely to match. Considerations relevant to these results are mentioned above in the Statistical Noise section.

DNATribes products match you against the various world populations and report your most likely matches. An example is shown below.

DNA Tribes Personal Genetic Analysis  
2/1/2006

Part B: Native Match

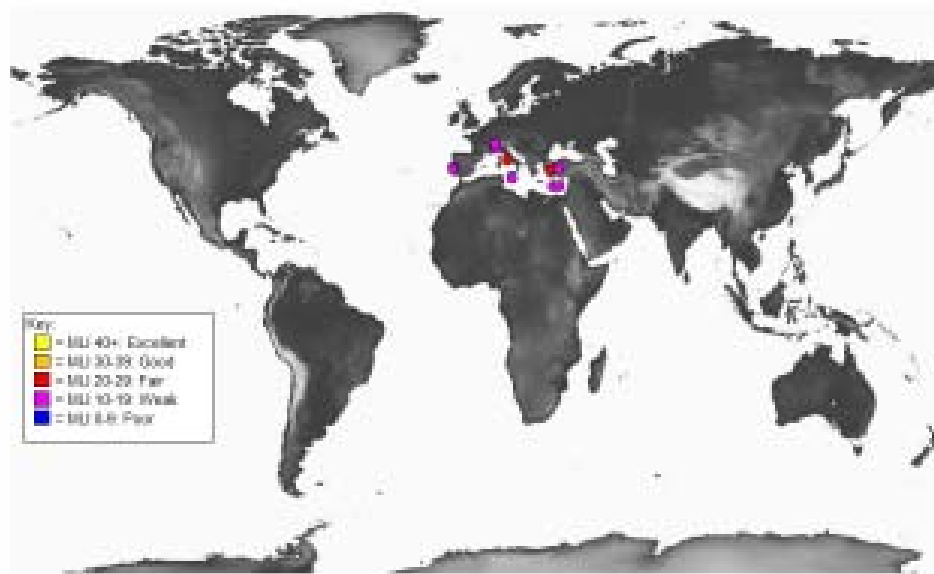
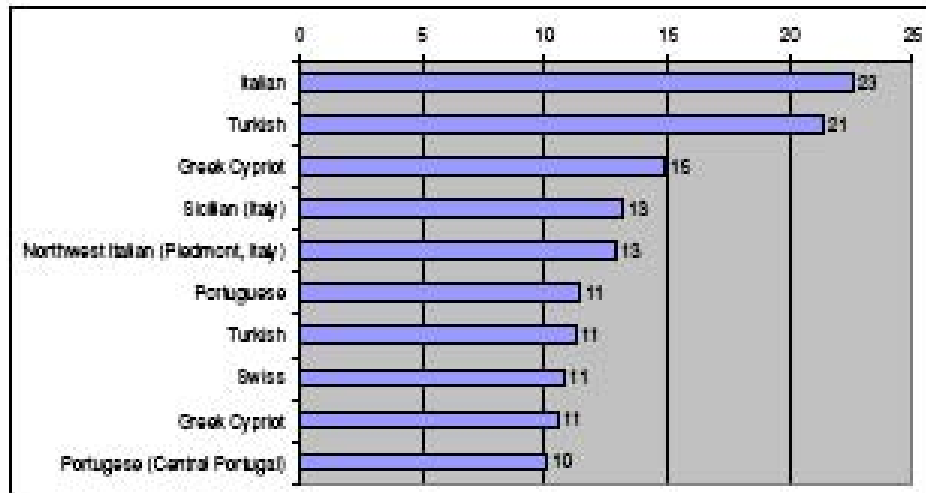

Their reports begin at about \$99 and they can also provide CODIS Marker testing if you have not been tested elsewhere.

### D9S919 Autosomal Allele

From the halls of academia a paper was published a couple of years ago that indicated that about 30% of the Native Americans tested carry a certain value for this particular autosomal marker. These values are not known to occur in other populations. This makes this particular marker extremely useful in determining whether an individual carries Native American admixture.

A value of 9-10 confirms Native admixture, but a value of anything else does NOT disprove Native admixture.

This test is only available at Family Tree DNA for existing customers under Advanced Orders, Autosomal Markers, Panel 3, for \$15 plus a transfer fee of about \$10 if your DNA is not already in the Houston lab for advanced testing.

### **23andMe Ancestry Testing**

A recent entry into the field of consumer genetic testing is the firm 23andMe, owned by the wife of Google's founder. They are focused on testing that is not just for ancestry, but includes a significant amount of medical information. This is not equivalent to genetic genealogy testing, as there is no matching with others by surname, projects and etc.

What this does offer is a much wider range of tests on 580,000 locations on your genome. Today, you can't separate out the medical and ancestry testing, so if you don't want the medical, you're getting it anyway. Take a look at their website at [www.23andme.com](http://www.23andme.com) for details. The price is about \$400.

In addition to your Y-Line haplogroup (for males) and your mtDNA haplogroup, they also provide consumers with an estimation of their percentage of ancestry, although they only include European, Asian and African, and their sample size is small, in many cases about 50 individuals per population, which I feel is much too small to be reliable.

They recently introduced a feature called Native Ancestry Finder that evaluates your mtDNA and Y-line haplogroups, plus your percent of Asian heritage and tells you whether or not you're likely to have Native Ancestry. In my case, it says I'm unlikely, but that it's possible beyond 5 generations. Given my finding at their lab of 99% European and less than 1% Asian, they're not incorrect, but their evaluation adds nothing that I didn't already know from other sources. Their results are the lowest for Native/Asian/African admixture of all of the testing companies.

Having said that, here is an example of the ancestry results.

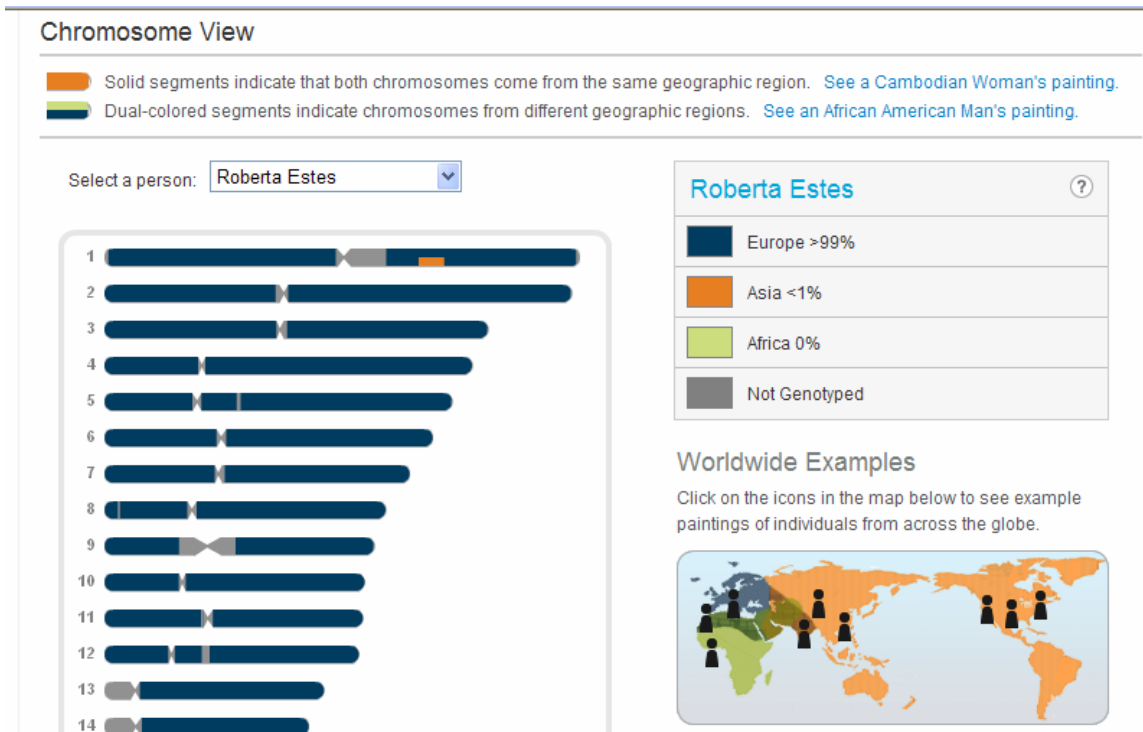

## DeCode Genetics

Another entrant into the same arena, about the same time, is DeCode Genetics from Iceland with their deCodeMe product offering. DeCode Genetics is a well known biomedical company for their research into heart disease and related genetics. Unfortunately, with the Icelandic government's collapse following the banking industry crisis, deCode Genetics is now in bankruptcy, but is still functioning. You can see their products at [www.decodeme.com](http://www.decodeme.com).

The ancestry portion of their offering is only available if you purchase the entire testing package, which costs \$985. Their package is similar to 23andMe in that they offer primarily medical testing.

Here are examples of their ancestry results. Of interest, they display the entire X chromosome which 23andMe does not. In my case, this is a critical piece of information as my "Asian" ancestry is pronounced on the X chromosome. The X chromosome has a particular inheritance pattern and this limits the possibility of who, on my pedigree chart, contributed that "Asian" DNA substantially.

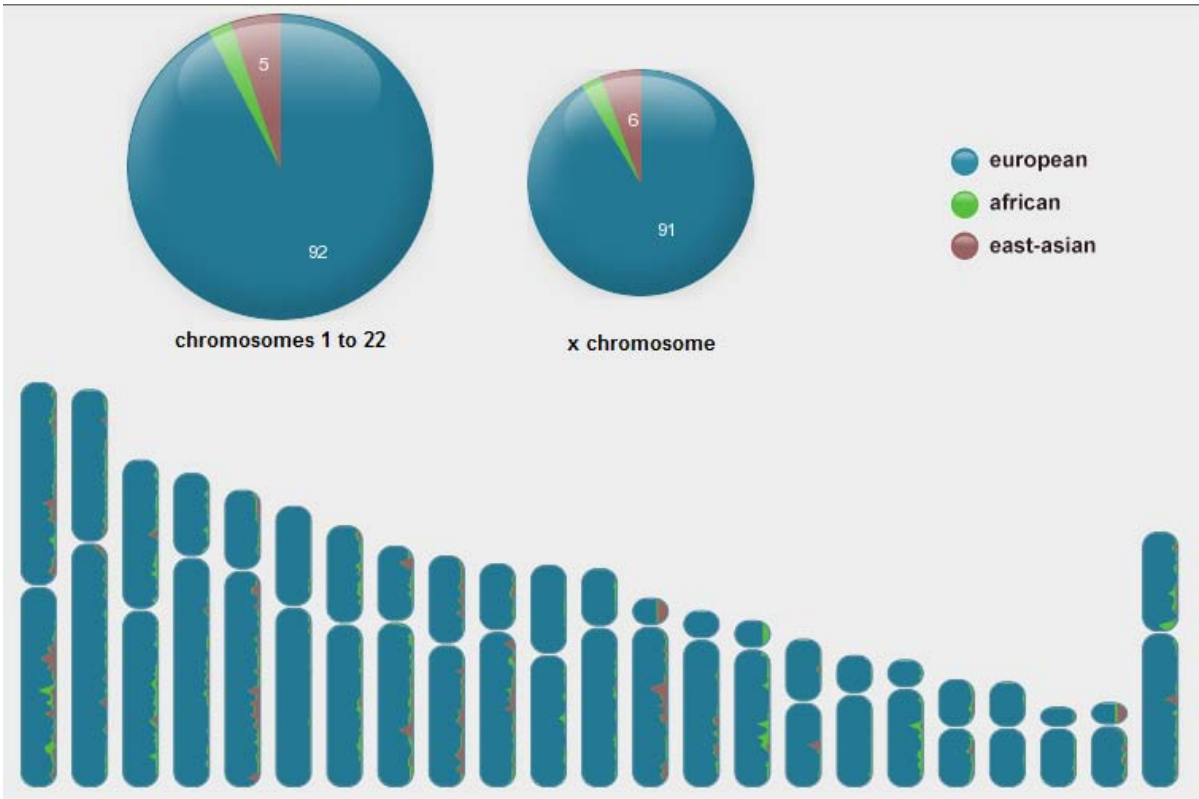



## Summary

There are only two tests that can provide you with solid evidence of the source of your Native American or other ethnic ancestry. Those are Y-line and mitochondrial DNA tests. It's important to try to fill in the blanks in your family tree pedigree chart by testing relatives who carry the Y-line and/or mtDNA of the lines of your tree that you cannot personally be tested for. It's also important to test at Family Tree DNA, because they provide SNP testing for accurate haplotype identification for both mtDNA (free) and Y-line (if it cannot be accurately predicted based on identical matches to SNP tested individuals). Additionally they provide surname, geographic and haplogroup projects and customer support (by a qualified person) by phone or e-mail if needed.

In addition, two types of autosomal testing can provide useful clues as to the percentage of your ethnic heritage and the geographical source. DNAPrint provided percentages of ethnicity of the 4 major world groups, European, Asian, African and Native American, but they are no longer in business. DeCodeMe and 23andMe provide something slightly similar in their predictions, but neither test for Native ancestry. People of European descent must allow Asian heritage to infer Native Ancestry.

Codis marker testing is another type of autosomal test used to determine the Codis marker values which in turn can be used to map those marker values

against known population groups. OmniPop is a tool that is used to view population matches, although issues persist relative to the identification of individuals and populations used by OmniPop and other tests of this type. DNATribes provides a population matching service using their internal database.

D9S919, an autosomal allele, can be tested through Family Tree DNA who also provides Codis marker testing. The values of 9-10 can confirm Native ancestry, but other values do not eliminate the possibility.

DNAexplain provides autosomal analysis services for Omnipop and other public databases in addition to analysis services for Y-line and mtDNA test results.

All genetic genealogy results need to be accompanied by genealogical research to unravel the historical context for the lives and trials of our ancestors. DNA testing may well answer the question what and who, but the why is typically revealed only by studying the history of the times in which they lived.

*Roberta Estes*

Copyright 2007-2009, Roberta Estes, all rights reserved